

BELLA FIGURA

Amphora Lamp

TL824

Collection Name
VEGA COLLECTION

The Amphora table lamp pays homage to ancient civilisations who bestowed the names of their gods and goddesses on some of the celestial bodies we can witness with the naked eye. The naming of these astronomical discoveries gives them personified characteristics which in turn gave us inspiration for a number of the works included in this collection. An Amphora, chic and strong in silhouette, was often rewarded to victors in contests such as the Panathenaic games, thus the symbol of praise we chose to honour these ancient discoveries.

Compatible with



Yacht Club



TL824 in Jasper and Polished Nickel with 13" Tall Drum Shade in Bennett's Crepe Satin Dill 1806W/120

Available Finishes

Ceramic Colours



Chalk



Crackle



Dapple Grey



Jasper



Starry Sky



Tabasco

Neck and Bulb Holder

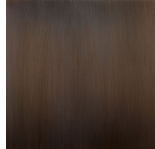

Bronze

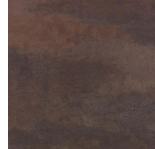

Old English
Brass



Polished Brass



Polished
Nickel

Silk Flex Choice



Black



Cream



Brown



Silver

Available Sizes

Size One

TL824,

Height: 57.8 cm (22.76")

Diameter: 21.5 cm (8.46")

1 x 40W E27

Max Watt and Lamps: 40W x 1

Cable Exit: Bottom

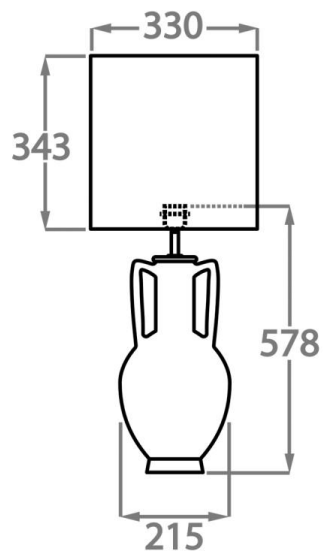

Dimensions are measured from the base of the lamp to the middle of the bulb holder and are excluding shade.

Overall height with recommended 13" tall drum shade is 88.3cm - 34.8"