

# BELLA FIGURA

## Bodice Lamp

TL663

Collection Name

**MOONLIGHT COLLECTION**

The Bodice table lamp is the English Rose of this latest collection; a feminine personality composed of elegance and beauty with an unmistakably graceful demeanour. This table lamp is comprised of a mouth blown body of glass and a solid, spun brass neck, both deftly crafted in the south of England.

**IMPORTANT NOTE** - Raincloud, Nightwatch and Ballet glass finishes are currently only available as singles.



TL663 in Storm and Pewter with a 12" Oval Shade in James Hare 8308/03

### Available Finishes

#### Glass Finish

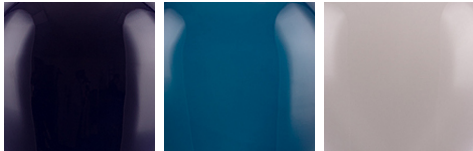

Ink Nightwatch Raincloud

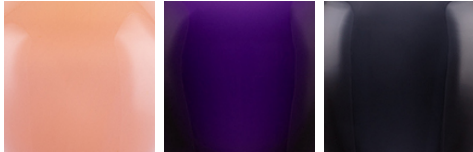

Ballet Indigo Storm

#### Neck and Bulb Holder



Polished Brass Pewter Polished Silver



Antique Brass

#### Recommended Shade(s) (OPTIONAL)

12" Oval

#### Silk Flex

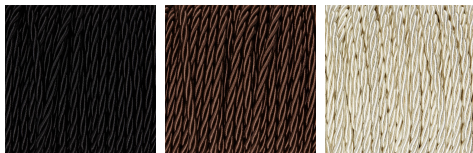

Black Brown Cream



Silver

## Available Sizes

---

### One size only

TL663,

Height: 36.5 cm (14.37")

Diameter: 16 cm (6.3")

Depth: 12 cm (4.72")

Bulbs: 1 x 40W E27

Net Weight: 9 kg / 20 lb Cable Exit:

Top

Dimensions are measured from the base of the lamp to the middle of the bulb holder and are excluding shade

The overall height with a 12" oval shade is 57cm

Finish note: As these glass lamps are handmade by our artisans in England, they may vary slightly from piece to piece in dimension and appearance