

# BELLA FIGURA

## Vortex Lamp

TL816E

Collection Name  
**VEGA COLLECTION**

Each Vortex table lamp is a unique art form. No two pieces are exactly the same, owing its sculptural form to a completely handmade, mould-free creation which allows for the unconstrained formation of each lamp's graceful twists and folds. We find ourselves entranced by the frozen fluidity of the Vortex glass, which evokes contemplation with its extraordinary beauty. **IMPORTANT NOTE** - Amber and Midnight glass finishes are currently only available as singles.

### Compatible with



Express



TL816 in Midnight and Polished Brass with 10" Tall Drum Shade in Bennett's 1806W-4501

### Available Finishes

#### Glass Finish



Ballet

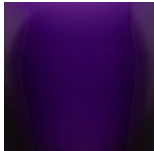

Indigo

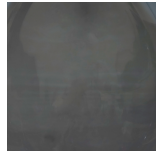

Midnight



Celeste

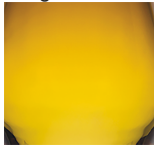

Amber

#### Neck and Bulb Holder



Antique Brass



Pewter



Polished Brass

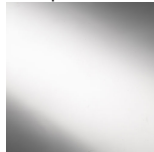

Polished Nickel

#### Recommended Shade(s) (OPTIONAL)



10" Tall Drum

#### Silk Flex

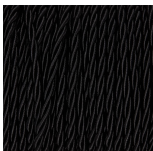

Black



Cream

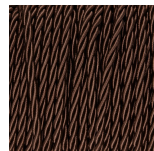

Brown



Silver

Available Sizes

---

**Size One**

TL816,

Height: 34.5 cm (13.58")

Diameter: 12 cm (4.72")

Bulbs: 1 x 40W E27

Cable Exit: Top

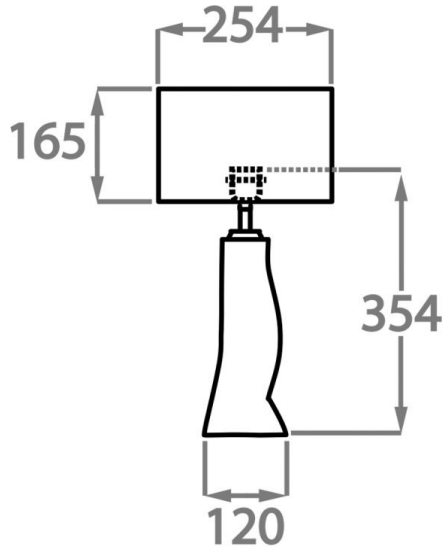

Dimensions are measured from the base of the lamp to the middle of the bulb holder and are excluding shade.  
Overall height with recommended 10" tall drum shade is 56.9cm - 22.4"