

BELLA FIGURA

Vortex Lamp

TL816E

Collection Name
VEGA COLLECTION

Each Vortex table lamp is a unique art form. No two pieces are exactly the same, owing its sculptural form to a completely handmade, mould-free creation which allows for the unconstrained formation of each lamp's graceful twists and folds. We find ourselves entranced by the frozen fluidity of the Vortex glass, which evokes contemplation with its extraordinary beauty. **IMPORTANT NOTE** - Amber and Midnight glass finishes are currently only available as singles.

Compatible with



Express



TL816 in Celeste and Antique Brass with 10" Tall Drum Shade in Bennett's 1806W-4501

Available Finishes

Glass Finish



Ballet

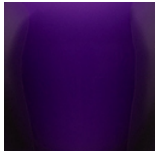

Indigo

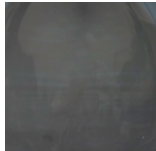

Midnight



Celeste

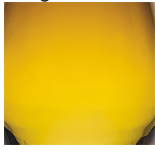

Amber

Neck and Bulb Holder



Antique Brass



Pewter



Polished Brass

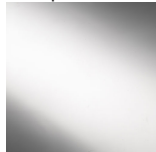

Polished Nickel

Recommended Shade(s) (OPTIONAL)



10" Tall Drum

Silk Flex

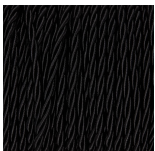

Black



Cream

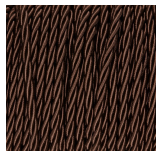

Brown



Silver

Available Sizes

Size One

TL816,

Height: 34.5 cm (13.58")

Diameter: 12 cm (4.72")

Bulbs: 1 x 40W E27

Cable Exit: Top

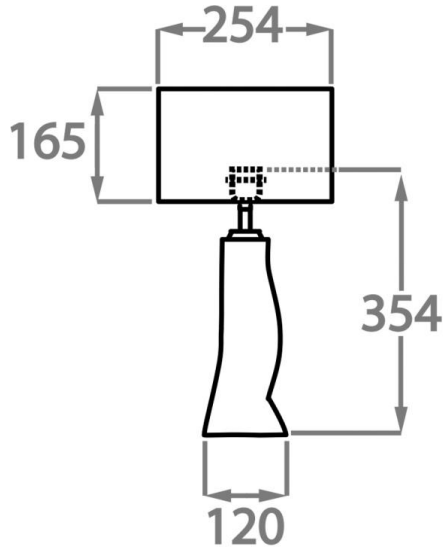

Dimensions are measured from the base of the lamp to the middle of the bulb holder and are excluding shade.
Overall height with recommended 10" tall drum shade is 56.9cm - 22.4"